

linea xs eco



RGBW |





TECHNISCHES DATENBLATT

linea xs eco

RGBW |

Technische Daten

Abmessungen	46 mm x 57 mm [B x H] 1.80 in x 2.25 in [B x H]
Leuchtenlängen	324 mm, 477 mm, 629 mm, 782 mm, 934 mm, 1087 mm, 1239 mm 12.76 in, 18.78 in, 24.77 in, 30.79 in, 36.78 in, 42.80 in, 48.78 in
Leuchtentyp	  RGBW RGBA
Farbtemperaturen W-Kanal	2200 K, 2700 K, 3000 K, 4000 K * Projektbezogene LED-Farben für RGBW/RGB möglich.
Abstrahlwinkel	8°, 10°, 23°, 43°, 8° x 31° 10° x 42°, 12° x 60°, 14° x 100°, 30° x 60°, 60° x 30°
Lichtstrom	324 mm (12.76 in): 558 lm 477 mm (18.78 in): 837 lm 629 mm (24.77 in): 1116 lm 782 mm (30.79 in): 1395 lm 934 mm (36.78 in): 1674 lm 1087 mm (42.8 in): 1953 lm 1239 mm (48.78 in): 2232 lm
Lichtquelle	324 mm (12.76 in): 8 LEDs 477 mm (18.78 in): 12 LEDs 629 mm (24.77 in): 16 LEDs 782 mm (30.79 in): 20 LEDs 934 mm (36.78 in): 24 LEDs 1087 mm (42.8 in): 28 LEDs 1239 mm (48.78 in): 32 LEDs
Farbwiedergabeindex	R _a >= 80
Entblendung	optional: <ul style="list-style-type: none">▪ internes Wabenraster▪ internes lineares Entblendungsraster
LED-Binning	
MacAdam-Ellipsen Binning	3
Steuerung	DMX

Eingangsspannung	Netzteil: extern 36 VDC		
Wirkleistungsaufnahme	324 mm (12.76 in):	Max. 5 W	
	477 mm (18.78 in):	Max. 7.5 W	
	629 mm (24.77 in):	Max. 10 W	
	782 mm (30.79 in):	Max. 12.5 W	
	934 mm (36.78 in):	Max. 15 W	
	1087 mm (42.8 in):	Max. 17.5 W	
	1239 mm (48.78 in):	Max. 20 W	
Schutzklasse	II		
Lagertemperatur	-40 °C / +80 °C -40 °F / +176 °F		
Betriebstemperatur	-40 °C / +40 °C -40 °F / +104 °F		
Einschalttemperatur	-25 °C / +40 °C -13 °F / +104 °F		
Lebensdauer [L70]	65'000 h @ 25 °C (77 °F) 40'000 h @ 40 °C (104 °F)		
Gehäuse	Aluminium-Strangpressprofil		
Gehäusefarbe(n)			
	Aluminium natur eloxiert (Standard)	Schwarz eloxiert	
Linse	Gehärtetes Sicherheitsglas, extra weiß		
Gewicht	324 mm (12.76 in):	1,5 kg (3.31 lbs)	
	629 mm (24.77 in):	2,1 kg (4.63 lbs)	
	934 mm (36.78 in):	3,2 kg (7.05 lbs)	
	1239 mm (48.78 in):	4,4 kg (9.70 lbs)	
Schutzart	IP66		
Umgebung			
	indoor	outdoor	
Schlagschutz	IK08		
Zulassungen			

Abstrahlwinkel

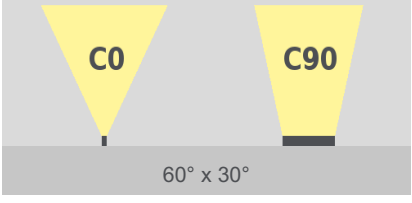
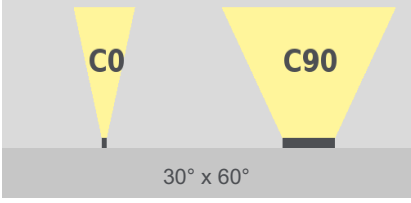
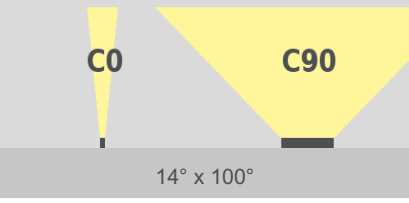
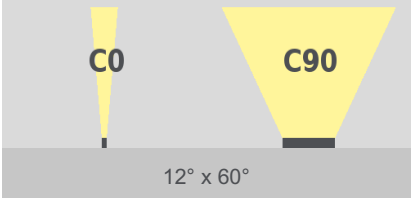
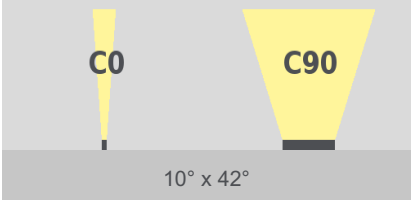
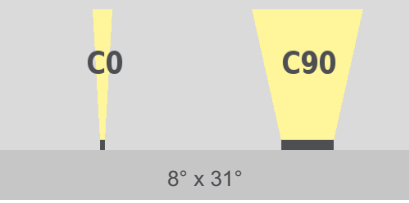
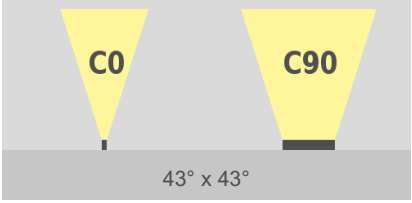
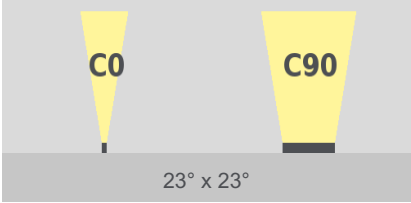
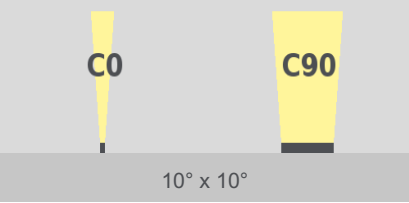
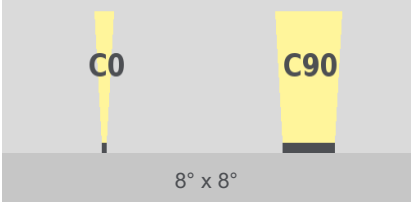

Technische Zeichnung

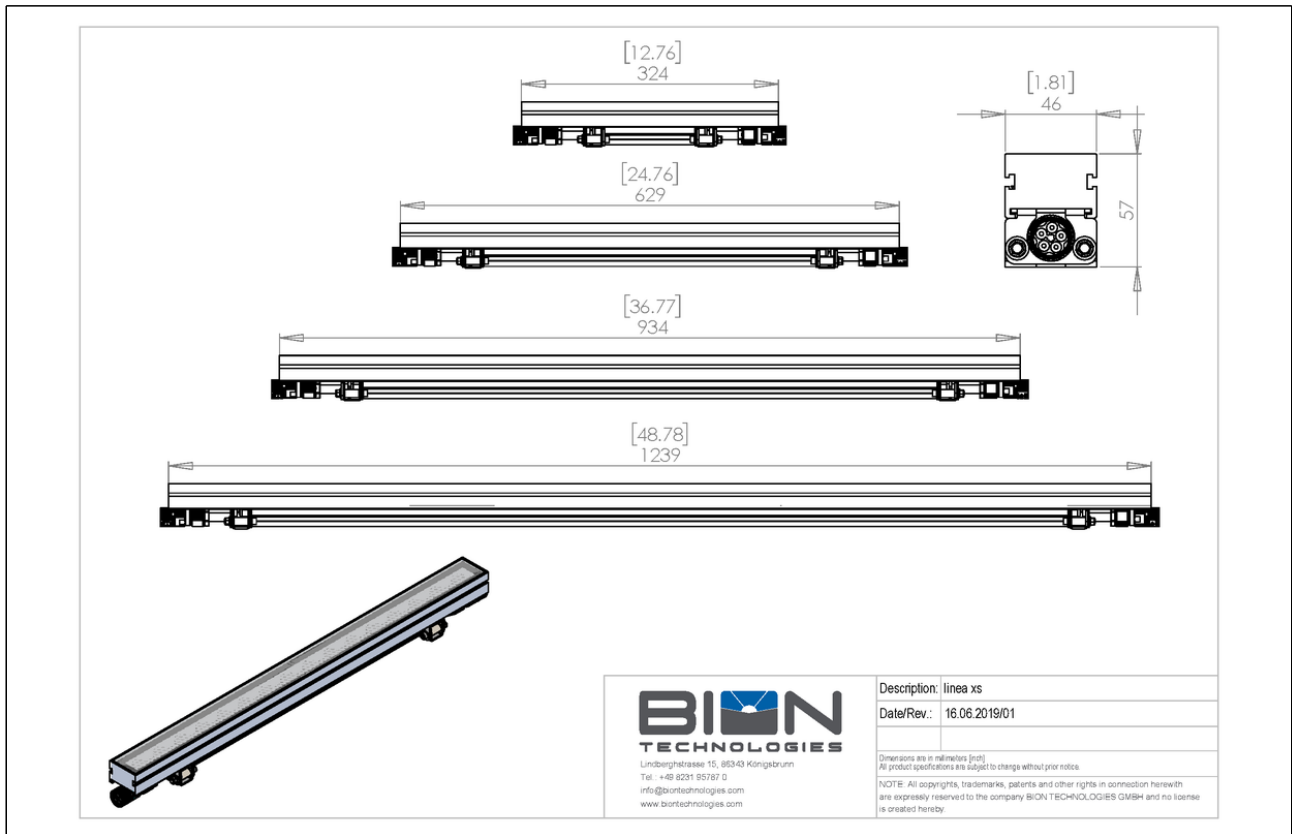

Projekt	Leuchten#	Datum
		Firma



Bestellinformationen

Wählen Sie Ihre Wunschkonfiguration aus und schreiben Sie dann die Kodierung in das entsprechende Feld, um somit die Produktnummer zu erstellen.

LIN-XS-ECO- _____ - DIM-DMX - _____ - _____ - _____ - _____ - _____ - _____ - Y01

TYP - LICHTFARBE	DIMMUNG	LEUCHTENLÄNGE	ABSTRAHLUNG	GEHÄUSEFARBE	ENTBLENDUNG	VERDRAHTUNGS KONFIGURATION	ANSCHLUSSLEITUNGSLÄNGE	BEFESTIGUNGSOPTION
RGBW22 RGBW - 2200 K RGBW27 RGBW - 2700 K RGBW30 RGBW - 3000 K RGBW40 RGBW - 4000 K RGBA RGBA	DMX Dimmbar - DMX	324 324 mm / 12.76 in 477 477 mm / 18.78 in 629 629 mm / 24.76 in 782 782 mm / 30.79 in 934 934 mm / 36.77 in 1087 1087 mm / 42.8 in 1239 1239 mm / 48.78 in	8X8 8° x 8° 10X10 10° x 10° 23X23 23° x 23° 43X43 43° x 43° 8X31 8° x 31° 10X42 10° x 42° 12X60 12° x 60° 14X100 14° x 100° 30X60 30° x 60° 60X30 60° x 30°	AA Aluminium natur eloxiert (Standard) BA Schwarz eloxiert	OP Keine Entblendung HL internes Wabenraster LL0 internes lineares Entblenderaster	IOCC IN/OUT mit Steckverbindung IXCX nur IN mit Steckverbindung IOOC IN offenes Ende / OUT Buchse IOOO IN/OUT mit offenen Enden IXOX nur IN mit offenen Enden	ETE Ende zu Ende- Verkabelung 003 + 30 cm (ca. 1 ft) 006 + 60 cm (ca. 2 ft) 009 + 90 cm (ca. 3 ft) 012 + 1,2 m (ca. 4 ft)	ND ohne Halter BS Universalhalterung

* Projektbezogene Optionen sind verfügbar - Bitte kontaktieren Sie Ihren Ansprechpartner für weitere Informationen.



Lindberghstrasse 15
86343 Koenigsbrunn
Tel: +49 (0)8231/95787-0
Fax: +49 (0)8231/95787-29
www.biontechnologies.com
info@biontechnologies.com

YouTube: <http://www.youtube.com/user/BIONTECHNOLOGIES>

© 2024, BION TECHNOLOGIS GMBH
All rights reserved / Subject to change / Specifications may change without notice